

BÖLLHOFF

RIVKLE® B2007

The RIVKLE® Battery tool

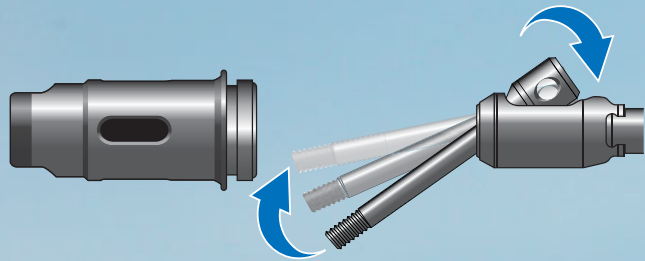



New quick tooling replacement

- No tool needed
- Uses the existing mandrel & anvil

Standard BÖLLHOFF ergonomic

- Single press trigger function to complete the entire cycle
- Comfortable & ergonomic handling

Advantages:

- 3 kN to 22 kN (M3-M10 steel)
- 24 RIVKLE® / min
- Up to 800 cycles with 1 battery
- Internal qualification done with 1 000 000 cycles
- BÖLLHOFF quality
- RIVKLE® nut & stud compatible
- Li-Ion technology battery



YouTube RIVKLE B2007



Electro-hydraulic technology

- Well balanced
- Power & reliability in a reasonable weight

Soft coverings for comfortable handling and for tool protection

LCD screen

- Load adjustment
- Setting parameters menu
- Battery level information



- Unscrewing button

RIVKLE® B2007 – Cordless battery tool for RIVKLE® nut & studs

Built for intensive use

- Electro-hydraulic technology: the choice for ultimate performance with the best reliability whilst maintaining a reasonable weight
- Produces 600 to 800 cycles per battery
- 1 000 000 cycles qualification – BÖLLHOFF quality

Optimized ergonomic design

- Comparable weight to the P2007 when fitted with hose

B2007 	Tool + Tooling + Battery	Total weight
	2,12 + 0,07 + 0,30	2,49 kg
P2007  Pneumatic	Tool + Tooling + Pneumatic	Total weight
	2,20 + 0,07 + 0,33	2,60 kg

- Well balanced tool
- Smart lighting to see in dark conditions



- Precise force adjustment, easy to do from the screen (possibility to lock it in the menu)
- Full menu to personalize your tool to your wish

Main characteristics

Setting force range kN	RIVKLE® capacity	Setting stroke max	Cadency RIVKLE®/min	Weight (Tool + Tooling + Battery) kg
3 → 22*	Steel: M3 → M10* Stainless steel: M3 → M8*	7 mm	24	2,49

* Above 18 kN (M10 steel & M8 Stainless steel) please use fork adaptor & specific tooling

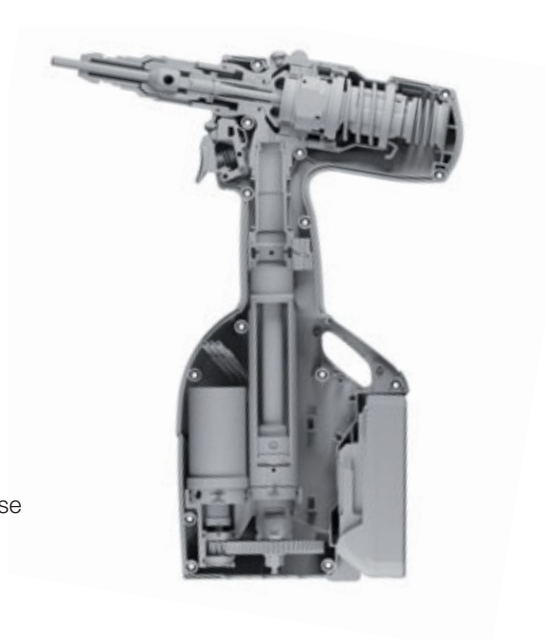











Well balanced

RIVKLE® B2007



	Connection made for Europe 	Connection made for US 
Package with 1 battery	236 166 01 000	236 168 01 000
Package with 2 batteries	236 167 01 000	236 169 01 000

Tooling

				3 → 18 kN					18 → 22 kN	
				M3	M4	M5	M6	M8	M8	M10
Mandrel			236 113 XX 020	03	04	05	06	08	236 913 08 110	236 913 10 019
			376 113 XX 020	-	04	05	06	08	-	
Anvil			236 113 XX 030	03	04	05	06	08	08	10
			376 113 XX 030	-	04	05	06	08	-	
Fork and nose for studs & force >18 kN (M8 & M10)			236 166 00 303 236 166 00 304						X	X
 Tooling box			236 113 00 002	X	X	X	X	X	-	

ex: to set M10 RIVKLE® nut, please order the specific nose + fork + mandrel + anvil, so 236 166 00 303 + 236 166 00 304 + 236 913 10 019 + 236 113 10 030

Accessories

Accessorie	Code	Accessorie	Code
 Original battery 14,4V 2,6AH - Li-Ion	282 590 30 350	 Tool support	236 166 00 308
 Original charger	EU: 282 590 30 352 US: 282 590 30 353	Screw kit adaptator	See general RIVKLE® catalogue 
 Battery with higher capacity 14,4V 4,0AH - Li-Ion	282 590 30 351	 Cord power supply	EU: 282 590 30 356 US: 282 590 30 357
 Multicharger 4 positions	EU: 282 590 30 354 US: 282 590 30 355		

BÖLLHOFF

Worldwide for you a strong partner – at 39 locations in 24 countries.

Böllhoff Group

Please find your local contact on www.boellhoff.com
or contact us under fasteningtechnology@boellhoff.com

